



HAL
open science

Time Measures in Documents: The model of "Motifs Temporels Paramétrés"

Philippe Bootz, Xavier Hautbois

► **To cite this version:**

Philippe Bootz, Xavier Hautbois. Time Measures in Documents: The model of "Motifs Temporels Paramétrés". A Document (Re)turn, Peter Lang, pp.197-222, 2007. sic_00637789

HAL Id: sic_00637789

https://archivesic.ccsd.cnrs.fr/sic_00637789

Submitted on 3 Nov 2011

HAL is a multi-disciplinary open access archive for the deposit and dissemination of scientific research documents, whether they are published or not. The documents may come from teaching and research institutions in France or abroad, or from public or private research centers.

L'archive ouverte pluridisciplinaire **HAL**, est destinée au dépôt et à la diffusion de documents scientifiques de niveau recherche, publiés ou non, émanant des établissements d'enseignement et de recherche français ou étrangers, des laboratoires publics ou privés.

Time Measures in Documents : The model of “Motifs Temporels Paramétrés”

*By Philippe Bootz, laboratoire Paragraphe, Université Paris8
and Xavier Hautbois, Institut d’Esthétique des Arts Contemporains, Université Paris1.*

1 Introduction

This article aims at presenting the model of “Motifs Temporels Paramétrés” (Parametrized Time Motifs) which can help to locate “Unités Sémiotiques Temporelles” (Semiotic Time Units) in artistic documents *in context of their reception*. Based on the aural reception of sound documents, this model is also pertinent when dealing with audiovisual and multimedia documents.

Led by François Delalande, musical semiology turned towards the issue of the reception of sound documents, taking for granted that a musical sign could not be treated in absolute terms; indeed, the relevance of an analysis is to be authenticated only by referring to studied behaviours : “ it is always a matter of establishing connections between elements in sound configurations and *human behaviours*, either productive or receptive” (Delalande, 1991). That is why the semiotic analysis program that he proposes is focused on strategies of listening (typical-listening) which condition us to perceive sounds in a particular and precise way¹. In collaboration with researchers and composers from the Laboratoire de Musique Informatique de Marseille (M.I.M.) (Laboratory of Computerized Music of Marseilles), he led a selection and a classification of extracts from musical works based on their aural reception and according to criteria of time significance. Nineteen “Unités Sémiotiques Temporelles” (UST) have been compiled in that classification (MIM, 1996). “A UST is a category of equivalent musical snatches which have a precise time significance linked to their morphology, even out of their musical context.” (Delalande in MIM 1996, 18-19).

The UST system devised by the MIM proved relevant in the analysis of documents extracted from entire musical works (MIM 2002). Moreover, the existence of UST as semiotic units linked to time-related mental representations has been given substance to by recent UST categorization experiments, based on musical extracts provided by the MIM. These spatial representations seem to fit with a spatial coding of time. The appellation of UST, often relating to specific movements², is highly relevant in this regard.

The relevance of UST seems to extend far beyond the strict boundaries of sound documents. Using definitions and properties of the signified levels of these units as detailed by the MIM, we have noted in multimedia products (*La colonie* by Alexandre Gherban³, *Avec tact* by Antoine Schmitt⁴), in experimental movies (*Rhythm 21* and *Diagonal symphony* by Hans Richter⁵, *Etude n° 8* by Oskar Fischinger⁶), and in experiments with lights (*Opus 161* by Thomas Wilfred⁷), visual patterns that are strongly analogous to UST in music. If it is true that UST are really linked to time-related mental representations, that system could constitute a broadly “a-media” semiotic system, independent from any specific media, and could be applied to any kind of document.

¹ On this topic, see the example of Debussy which he developed in Delalande (1989).

² Some examples of UST : *Qui tourne*, *Qui veut démarrer*, *Trajectoire inexorable...*

³ Published in *alire12*, cd-rom, Villeneuve d’Ascq, MOTS-VOIR, 2004.

⁴ Available on the author’s website, <http://www.gratin.org/as/avectact/index.html>.

⁵ Centre Pompidou, Musée National d’Art Moderne.

⁶ Centre Pompidou, Musée National d’Art Moderne.

⁷ Luminous machine, Carol and Eugene Epstein’s collection, Los Angeles, 1965-1966.

Nevertheless, the description provided by the MIM is not sufficient to widen that system to include all media. Indeed, that description is essentially qualitative and uses metaphoric terms as well as an exclusively musical vocabulary. On the level of the signified, the use of metaphors raises no problem, but as regards the signifier level, they hardly provide an efficient description. On the other hand, the use of a musical vocabulary in the description of a signifier complicates the formal analogies between the world of sound and the visual one. That is why, in that field, analyses deriving from that description have remained purely qualitative.

Thus, it proved necessary to propose a more abstract and systematic description of these UST on the level of their signifier, a description which would not rely on musical variables any. We named this “Motif Temporel Paramétré” (Parametrized Time Motif). Of course, the components thus defined remain carried by sound variables, as they are carried by other variables in visuals.

That work on the signifier enabled us to proceed to sound syntheses of UST. Then we tackled the MTP analysis of a visual work on a quantitative level. The MTP system also happens to be easy to program and should help us elaborate simulations or facilitate the relationship between sound and image in multimedia.

2 Methodology.

We have focused on the sound-morphology of multiple sound extracts provided by the MIM, so that we could detect time-variation rules in them, not to describe them accurately, but in order to detect oppositions between UST signifiers. Our analysis is thus not a signal analysis, but a semiotic analysis based on a set of oppositions. It is based on the actual UST classification, even though it enabled us to characterize the types of examples provided by the MIM, which a purely qualitative approach could not have done.

As a result, these variables were named pertinent variables and MTP determine their structure in time.

We have described that system in a graphical and analytical meta-language. The graphical language is well adapted to a standardized representation of the time variations of pertinent variables; the analytical language provides us with a clear description of the subdivision of the system into its constituent parts⁸.

We have adopted the analysis method based on the way the sound “sounds” and not on its signal analysis. This made the perception of pertinent variables easier, which can occur in a rather complex way in musical snatches. Further, the observation of wave files and sound graphics helped us measure the quality of some parameters. Eventually, simulations gave us the opportunity of improving our analysis.

3 Overview of the system

3.1 The system units

UST provide us with an iconic transcription of time shapes, that are often also characteristic of states of motion. Hence, they form a semiotic system with no corresponding cutout⁹, so that it is legitimate to focus only on the study of their signifier, knowing that only the association of a signifier with a signified constitutes a sign. That signifier level, that of MTP, forms an articulate system organized in distinctive units. Indeed, a UST cannot be split into smaller signifying units, whereas a MTP is organized on several levels. Before we describe precisely each level of articulation and each UST, let us establish an overview of the system units.

⁸ Let us consider the suggestive impact of formulae in chemistry.

⁹ The vocabulary we use is that of Klinkenberg (1996), “système sémiotique à découpage non correspondant”.

A « Motif Temporel Paramétré » describes the signifier of a UST by using time functions which represent the overall appearance of the time-pattern of the pertinent variables v on the length of the UST.

Two pertinent variables v are enough to describe the signifier of a sound UST. We named them F and I. These abstract variables are characteristics of the signifier but they are materialized by physical parameters of the sign stimulus. Thus, the variable F is materialized by the “melodic” aspect of the sound (frequencies evolving in time). The variable I is principally materialized by the intensity of the sound, but, in certain cases, it can also be by its brilliance, or in other words : the spectral richness of sound.

Each UST is systematically described with these two variables. Nevertheless, the pattern of only one of these variables suffices to perceive the UST in a great many cases. Consequently, we named it “main variable of the UST”. When the UST does not possess such a variable, the two pertinent variables are of equal importance, for the perception is as influenced by the time-pattern of one as it is by the time-pattern of the other.

In a sound, distinct time-layers may be noticeable and pertinent for time semantics. In that case, a full set (F, I) shall be affected in each layer. These layers evolve simultaneously in the Motif and only their association affects the time-pattern that is identified on the semantic level of the UST. In a multilayer Motif, one layer at most is to have a main variable; it is called the main layer of the Motif.

UST are organized in phases. A phase is a part of the Motif which presents a strong opposition to the preceding and the following parts¹⁰. That opposition only concerns the main variable of the UST when the latter is characterized by it. It concerns the two pertinent variables simultaneously when both are of equal importance.

The temporal function of a pertinent variable shows one or several profiles following one another. A profile is a specific fragment of time which stands in opposition to those adjacent to it. It is based on a rule of association of elementary functions called profilemes. These profilemes help us build indiscriminately the profiles of the two variables F and I.

3.2 Profilemes

3.2.1 Parameters

Profilemes are characterized by three parameters: their shape, which defines the look of the elementary function’s time-pattern, their amplitude and a characteristic length, most often their actual length.

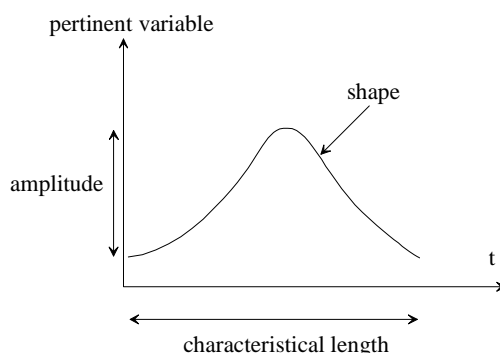

Figure 1 : examples of parameters of a profileme

3.2.2 Parametrical specificities

a) Shape specificities

We have devised a list of thirteen profilemes. They are divided in six classes, each one described by a normalized schema and a formula :

- ❖ the constant shape. Three profilemes belong to that class:

¹⁰ The precise definition of the phase is given in the following chapter.

- the *plat* (the flat shape), formula : Pl. It designates a non consequential variation of the v variable of about an average value which does not vary significantly on the characteristic length.
 - The *constante stricte* (strict constant), formula : Cst. Unlike the *plat*, the v variable of this profileme remains strictly constant in time on the characteristic length. On the level of frequencies, it may represent a sustained, resonant, or repeated note.
 - The *constante nulle* (zero constant), formula : O. It is a *constante stricte* of no amplitude at all. It does apply only to the I variable and helps us situate a rest in the music.
- ❖ the linear shape : its pertinent variable evolves monotonously, in a linear way in time, and its steep incline gives the impression of speed. In our system, no profileme is opposed to another by the worth of that steepness, so that the value of the slope on the diagram is unimportant, provided that it is not zero. In the analyzed extracts, the variation direction (ascending or descending slope) is not pertinent on the signified level, so that this class has only one profileme : L.
 - ❖ the curved shape : the pertinent variable evolves in a non-linear, monotonous way in time and its curved shape gives a feeling of acceleration. The value of that curve is not significant in the example, unless it is zero. Two profilemes are to be distinguished depending on the direction of their variation. The ascending curve is classified C+ and the descending one C-. In MTP for which the variation direction is not pertinent, these two classes are indiscriminately noted C.
 - ❖ the bell-shaped curve : in the profileme, the pertinent variable rises and then falls in time. Rectangular and triangular forms belong to this category (among other geometrical shapes). It is not the round shape of the bell which defines it, but the existence of an ascending front and a descending one on its characteristic length. There are two symmetrical profilemes and two dissymmetrical ones. The symmetrical ones are :
 - the *pulse*, noted II, in which the variable is zero if not placed on a short segment of time constituting the characteristic length of the profileme.
 - the *cloche symétrique* (symmetrical bell), noted CI, for which the ascending and descending parts develop along the whole characteristic length of the profileme.

The asymmetrical profilemes are asymmetrical because of the pertinent variation of their slope. They are distinguished by the steepness of their ascending line: respectively the *cloche dissymétrique à front raide* (dissymmetrical bell with a steep line), called CI+ and the *cloche dissymétrique à front lent* (dissymmetrical bell with a gentle line), called CI-. They spread along the whole characteristic length.

- ❖ the *peigne de Dirac* (Dirac comb), called pD : it is a periodically repeated peak. Unlike the others, it has no noticeable amplitude or shape. That shape only plays the role of an operator which enables us to draw periodical profiles. It is never directly observed.
- ❖ the *séquence ordonnée* (ordinate sequence), noted seq. It is a musical motion which possesses a proper temporality different from the preceding shapes. Its time structure is not defined here, it constitutes a shape perceived as slowly structured in time.

The basic profilemes are made up of the 12 profilemes other than the *peigne de Dirac*.

➤ Schematic representation and formulae of the profilemes :

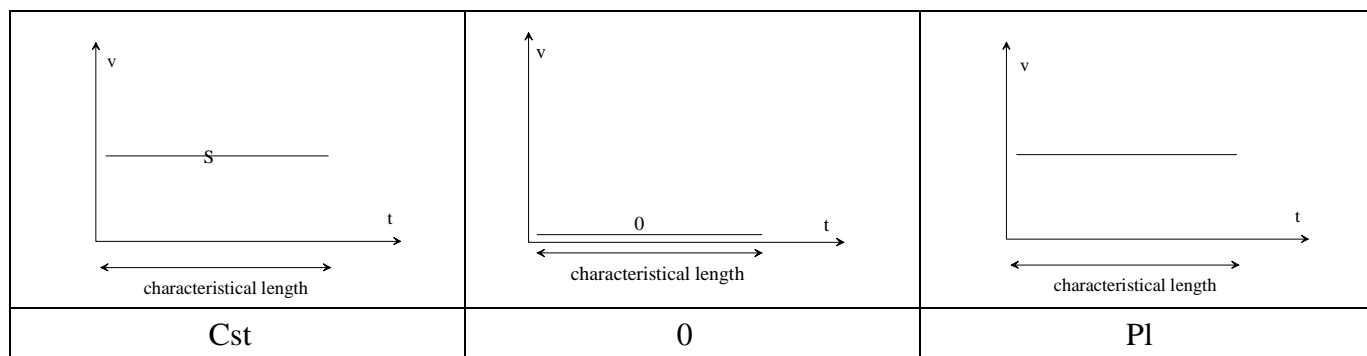

Figure 2 : constant shapes

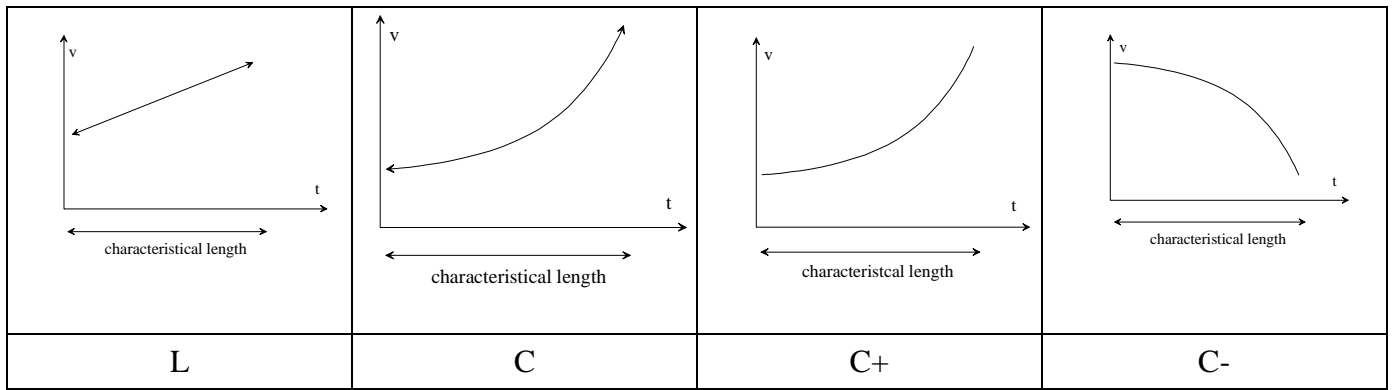

Figure 3 : linear and curved shapes

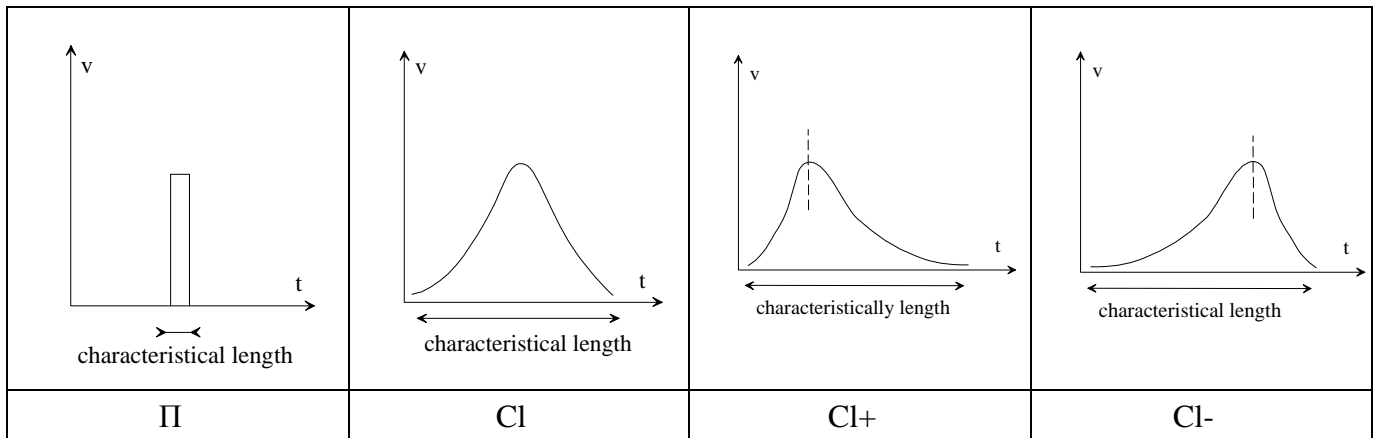

Figure 4 : bell-shaped curves

The *peigne de Dirac* as well as the *séquence ordonnée* will not be directly represented by their real shape on normalized schemata, but by specific symbols. The *peigne de Dirac* will be represented by a vertical dotted line topped by the T value of its period. In front of that line is placed the indication “Me” to point out that what is contained in that zone constitutes the elementary Motif which shall be repeated in the profile.

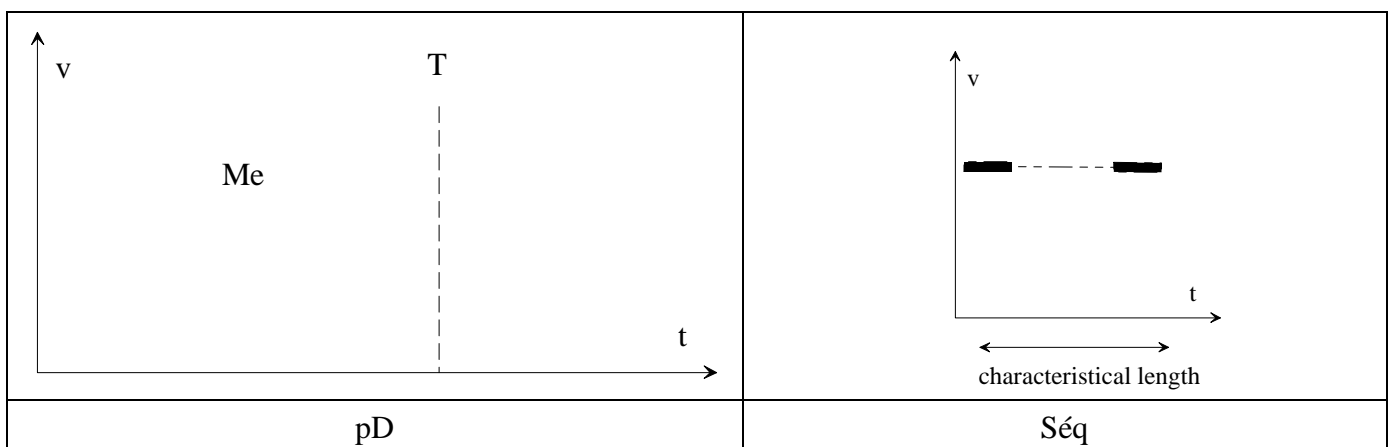

Figure 5 : normalized schemata of the *peigne de Dirac* and of the *séquence ordonnée*

b) Length specificities

Because they are built from the 4 characteristic lengths T0, T1, T2, and T3, the characteristic length of a profileme can belong to 6 value fields noted by the symbols T0, T1, T1=T2, T2, T3, T2 or T3. The T0 field corresponds to the value that is necessary to perceive a profileme. As regards sound variables, that value is about 300 ms. The T1 field typically corresponds to a duration shorter than 1 second. T2 corresponds to a length of several seconds. This T2 field seems to correspond to the length during which the profileme can be treated in working memory. T3 corresponds to a duration longer than 10 seconds, which is too long for the correspondent characteristics of the profileme to be treated in working memory.

These fields correspond to categories. The frontier between two adjacent fields has no signification. Thus, depending on the sound context of the profileme, a length of 0.9 second will sometimes be identified as a *T1*, sometimes as a *T2*. In certain cases, the field of ambiguous values between *T1* and *T2* is identified as a field in opposition to the others. We called it *T1=T2*. The measures we took on fragments of sound gave lengths in that field a value of approximately 1.5 s. Thus, *T1* is opposed to *T2*, and *T1=T2* is opposed to both *T1* and *T2*.

The field *T2 or T3* indicates that the corresponding length may get a value comprised between a few seconds up to more than ten seconds, or even a few dozens of seconds.

3.3 Profiles

3.3.1 Assembly grammar of profilemes

A profile is ruled by one of the following operations that affect the basic profileme:

- ❖ identification: the profile is directly made up of the basic profileme.
- ❖ the convolution of a basic profileme by a *peigne de Dirac*: the convoluted profileme is reproduced periodically depending on the period of the *peigne de Dirac*.
- ❖ the multiplication of the basic profileme by a *pulse*: the profile is made up of a fragment of the basic profileme (that which corresponds to the value of the *pulse* not equal to zero), the rest of the profileme being thus reduced to a zero value.
- ❖ the convolution of a basic profileme by a *peigne de Dirac* followed by the multiplication of a curve (*C+* or *C-*): the profileme is reproduced periodically and its mathematical envelope evolves in that reiteration according to the curve *C+* or *C-*.

It is easy to gather these assembly rules under a formula. If we note *P* the profile and *pf* the basic profileme, * the convolution and *X* the multiplication, we shall note these 4 rules respectively:

$$P = pf ; P = pf * pD ; P = pf X \Pi ; P = (pf * pD) X C+ \text{ (or } P = (pf * pD) X C-$$

Two successive profiles can be opposed by the amplitude of their basic profilemes, one being of a weaker amplitude than the other one. These oppositions in amplitude are marked by an arrow on the schema of the profileme and by the notation {+/-} in the formulae. Note that the amplitude of the *constante stricte* is always that of the end of the precedent profile.

3.3.2 Specificities of periodical profiles

In a periodical profile, the basic profileme can present variations in shape or in amplitude during its reiteration. These variations are noted by the symbol \neq in schemata or in formulae. Moreover, the period of reiteration can also vary from an elementary Motif to another one. In that case, it can increase strictly, reduce strictly or vary randomly in a direction or another. According to the rise or fall of the period, that variation is indicated by $P_{min} \rightarrow P_{max}$ ou $P_{max} \leftarrow P_{min}$ in schemata and formulae.

3.3.3 A rigorous definition of the phase

When a Motif has a main variable, a phase is always constituted by with a profile of that variable¹¹. When a Motif has no main variable, a phase is made up of two simultaneous profiles, one on each pertinent variable. A change in phase is effected only when these profiles differ *simultaneously* in every variable. The number of phases in the Motif is then equal to the number of profiles in the variable which possesses fewest of them. Practically, all multilayer Motifs have but one phase.

In the Motif, phases follow one another sequentially. In certain Motifs, one or several phases can recur. That repetition may be a redundance (some repetitions are then noted (n) on Motifs or formulae) or a periodical repetition (convolution of repeated phases with a *peigne de Dirac*).

¹¹ This latter being related to the profiles of the other variable which occurs at the same time.

3. 4 Time Motifs

Certain Motifs are delimited in time, in other words: their length is significant. Others are not delimited in time, that is, their length is infinite on the signifier level, even if the length of their stimulus is obviously a finite one.

3. 5 Normalized schematization and formulae

In schemata, the two pertinent variables use the same horizontal time axis: F is directed upwards and I is directed downwards. When the Motif has a main variable, it is noted on the corresponding axis. Profiles are separated by vertical dotted lines. The value of the characteristic length of the profile is indicated under its shape. Phases are not noted. A thicker vertical dotted line indicates the end to the Motif. In the case of a Motif delimited in time, the field of its complete time-width is noted behind the line. The distance which separates the limit of the former profile from the limit of the Motif has no signification in the schema. Each layer is the object of a schema and layers are separated by the symbol +. When the Motif has a main layer, it is the first represented. When a profile is multiplied by a curve, the envelope (the curve) is noted in dots.

In formulae, the Motif is delimited by square brackets. The profiles of pertinent variable are separated by a comma. The first variable indicated is I, the second one is F, according to the notation [I: formula of the profiles/F: formula of the profiles]. The field of the Motif's length is noted after the square brackets when it is delimited in time. Phases are noted by commas separating the two notations : I/F. The main variable, when it does exist, is noted by the letter p in front of I or F.

3. 6 UST

With these representation conventions, UST constitute the following system¹²

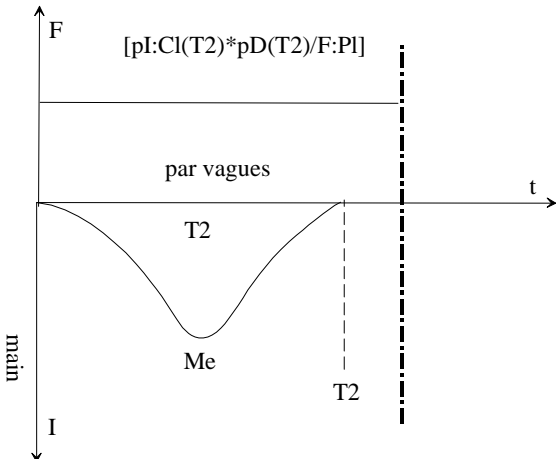
| UST | Motif Temporel Paramétré (Normalized schemata and formulae) | number of phases |
|-------------------------------------|--|------------------|
| <p><i>Par vagues</i> (Wavy)</p> |  | 1 |

¹² The represented UST are named after the impression conveyed by their patterns, respectively : *Wavy; Obsessive; Spinning; Run-up; Fall; Inexorable trajectory; On the way; Stretching; Braking; Tense/Stretched out; Suspension/Question; Which wants to get started; Directionless because of informational divergence; Directionless because of too many pieces of information; Stationary; Floating; Suspended; Heaviness; Moving forward.* (the translator)

| | | |
|---|--|----------|
| <p><i>Obsessionnel</i> (<i>Obsessive</i>)</p> | | <p>1</p> |
| <p><i>Qui tourne</i> (<i>turning</i>)</p> | | <p>1</p> |
| <p><i>Élan</i> (<i>Run-up</i>)</p> | | <p>3</p> |

| | | |
|--|---|----------|
| | <p>[pI:Pl(T2)/F:Pl, (n)(pI:C+(T1)/F:Pl, pI:Cst(T1)/F:Pl)]T2</p> | |
| <p><i>Chute (Fall)</i></p> | <p>[pF:Pl(T1ouT2)/I:Pl, pF:C(T2){+/-}/I:Pl]T2</p> | <p>2</p> |
| <p><i>Trajectoire inexorable (inexorable trajectory)</i></p> | <p>[pF:L(T2ouT3)/I:Pl]</p> <p>[pF:C(T2ouT3)/I:Pl]</p> | <p>1</p> |

| | | |
|--|---|----------|
| | <p>[pI:II(T1) *pD(T1<-,-> T2)/F:PI(T2ouT3)]</p> <p>trajectoire inexorable T2ouT3</p> <p>main I</p> <p>Me T1</p> <p>T1 → T2</p> | |
| | <p>[pI:C+(T2ouT3)/F:PI]</p> <p>trajectoire inexorable T2ouT3</p> <p>main I</p> | |
| | <p>[pI:L(T2ouT3)/F:PI]</p> <p>trajectoire inexorable T2ouT3</p> <p>main I</p> | |
| <p><i>Sur l'erre (on the ways)</i></p> | <p>Me</p> <p>sur l'erre T2</p> <p>T2 Me</p> <p>T2 → T2</p> <p>T2 ou T3</p> <p>[pI:(CI(T2)*pD(T2->T2)XC-/F:séq(T2)*pD(T2)] T2ouT3</p> <p>main I</p> | <p>1</p> |

| | | |
|--|---|---|
| | <p>Graph showing Force (F) and hand position (main) over time (t). The force curve has a plateau at Me and a peak at $T2$. The hand position curve is labeled with the formula $[pI:C-/F:séq(T2)*pD(T2)]T2ouT3$.</p> | 1 |
| <p>Étirement (Stretching)</p> | <p>Graph showing Force (F) and hand position (main) over time (t). The force curve is labeled $[pF:Cst(T2)/I:PI]T2$. The hand position curve is labeled 'étirement'.</p> | 1 |
| <p>Freinage (Braking)</p> | <p>Graph showing Force (F) and hand position (main) over time (t). The force curve is labeled $[pI:II(T1) *pD(T1=T2)/F:PI, I:II(T1)\{+/-\} *pD(T1 \rightarrow T1=T2)/F:PI]T2$. The hand position curve is labeled 'freinage'.</p> | 2 |
| <p>Contracté-étendu (Tense/ Stretched out)</p> | <p>Graph showing Force (F) and hand position (main) over time (t). The force curve is labeled $[F:séq(T1ouT2)/I:(II(T1)*pD(T1 \leftrightarrow T1)XC+, II(T1)\{+\}), F:Cst(T2)/I:PI\{-}]T2$. The hand position curve is labeled 'contracté-étendu'.</p> | 2 |

| | | |
|--|--|---|
| | <p style="text-align: center;">[F:séq(T1ouT2)/I:($\Pi(T1)*pD(T1 \leftrightarrow T1)XC+, 0(T0)) , F:Cst(T2)/I:Pl]T2$</p> | |
| <p><i>Suspension-interrogation (Suspension/ Question)</i></p> | <p style="text-align: center;">[(F:séq(T1ouT2)/I:séq)*pD(T2) , F:Cst(T1ouT2)/I:C-]T2</p> | 2 |
| <p><i>Qui veut démarrer (Which wants to get started)</i></p> | <p style="text-align: center;">[(pF:séq(T2)/I:Pl)*pD(T2) , pF:C(T2){+/-}/I:Pl{+/-})*pD(T2ouT3)]</p> | 2 |
| <p><i>Sans direction par divergence d'informations (Directionless because of informational divergence)</i></p> | <p style="text-align: center;">[(F:séq(T1ouT2)/I:séq)*pD(T1ouT2\leftrightarrowT1ouT2){\neq}]</p> | 1 |

| | | |
|--|--|----------|
| <p><i>Sans direction par excès d'information (Directionless because of too many pieces of information)</i></p> | | <p>1</p> |
| <p><i>Stationnaire (Stationnary)</i></p> | | <p>1</p> |
| <p><i>En flottement (Floating)</i></p> | | <p>1</p> |

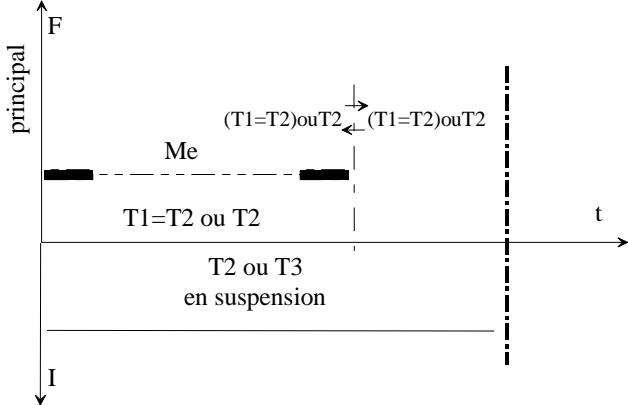
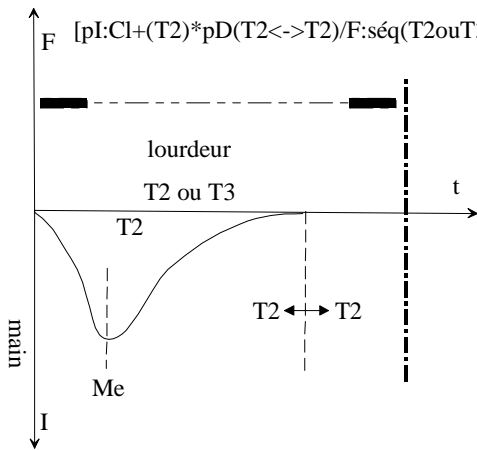
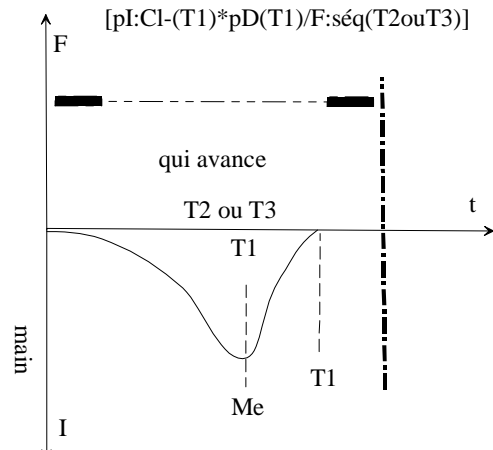
| | | |
|---|--|----------|
| <p><i>En suspension</i> (Suspended)</p> | <p>[pF:séq((T1=T2)ouT2)*pD((T1=T2)ouT2 <-,->(T1=T2)ouT2) /I:Pl(T2ouT3)]</p>  | <p>1</p> |
| <p><i>Lourdeur</i> (Heaviness)</p> | <p>[pI:Cl+(T2)*pD(T2<->T2)/F:séq(T2ouT3)]</p>  | <p>1</p> |
| <p><i>Qui avance</i> (Moving forward)</p> | <p>[pI:Cl-(T1)*pD(T1)/F:séq(T2ouT3)]</p>  | <p>1</p> |

4 MTP synthesis

The 21 MTP corresponding to the 19 UST were synthesized with the help of the OpenMusic V5.0 software, a graphical programming environment developed at the IRCAM and destined specially for computer-assisted composition.

We have worked directly from an initial sound-file to which we have applied intensity and frequency filters. All the simulations have been realized from a sound extract from the musical piece *La création du monde* composed by Bernard Parmegiani¹³. That extract presents a sound texture focused on comparatively stable frequencies. It hardly changes and only serves to fill the MTP with a sound texture.

¹³ *Lumière*, in *Métamorphose du vide*, 5'38 to 6'06.

We could have proceeded from other sound-files, but the more noticeable characteristics a sound-file has (melodic trait, percussive rhythm, etc.), the less the UST produced by filtration are considered typical.

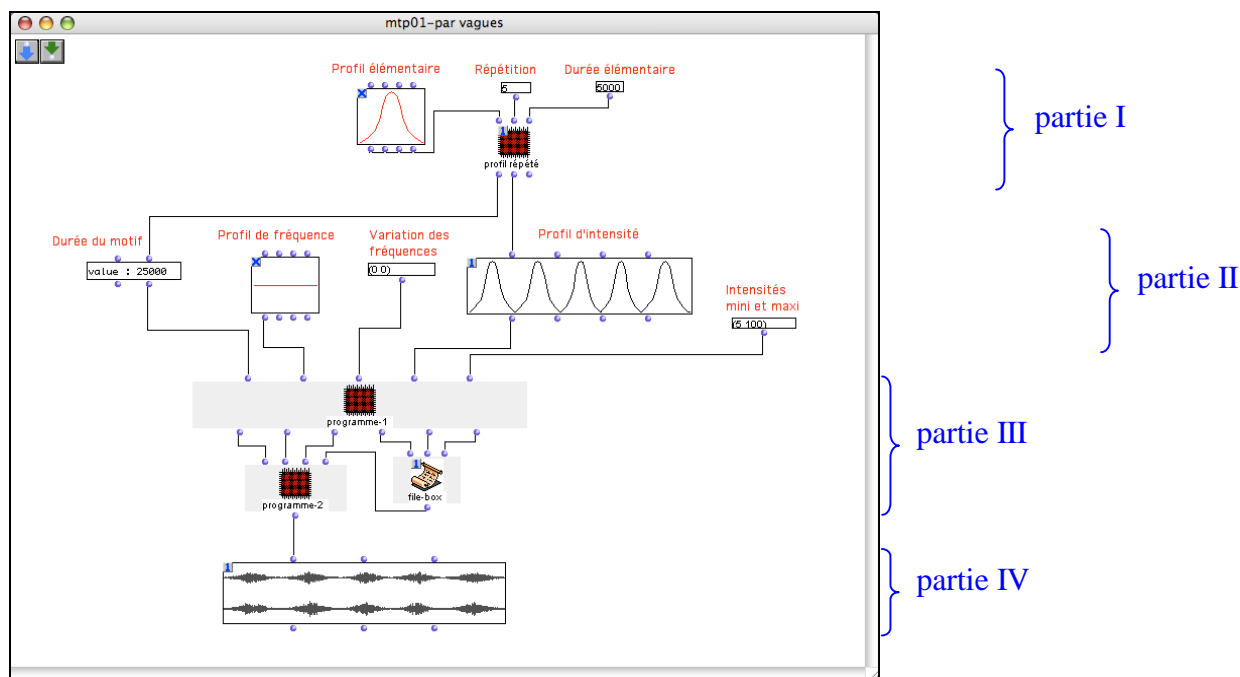
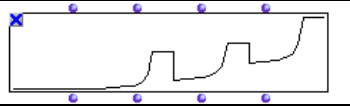
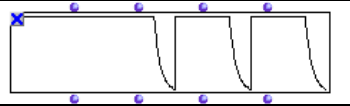
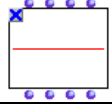
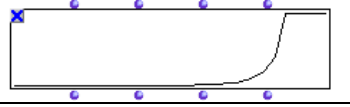
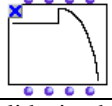
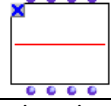
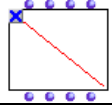
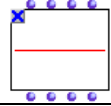
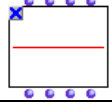
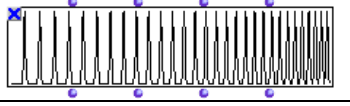
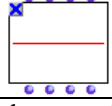
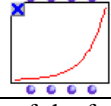
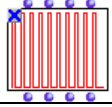
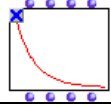
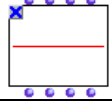
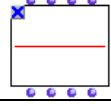
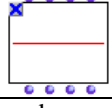
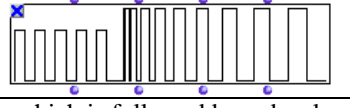
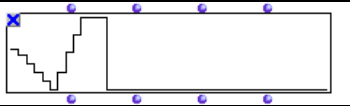
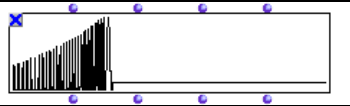
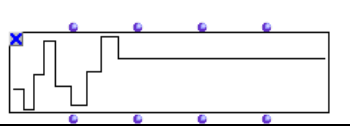
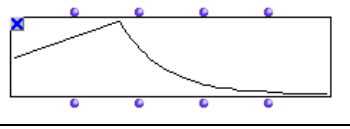

Figure 6 : simulation of the UST *Par vagues*.

The simulation program has been devised to allow the easy realization of a vast corpus of sound-samples, by playing on the different parameters and on the choice of the initial sound-file. Here is the example of the simulation of the UST *Par vagues* (Figure 6): The elementary profile corresponds to the profileme we used (here a bell-shaped one) and the adjacent boxes make its characteristics more precise: characteristic length (500 ms) and many repetitions in the *peigne de Dirac*. The total length of the Motif is then calculated (2500 ms) and the program builds up a comprehensive intensity profile. The frequency profileme is then introduced (here a *plat*), as well as its variations, whose every boundary is given in relative values regarding the actual sound frequency. Program 1 calculates the filter we get, corresponding to the MTP. Program 2 applies it on the original file (file-box) and the wave-file of the simulation is saved on a disk and displayed on the terminal box.

Here are the simulations we got:

| UST | Length of the MTP | Frequency profile (F) | F variations | Intensity profile (I) | I (min max) |
|---------------------|-------------------|-----------------------|--------------|-----------------------|-------------|
| <i>Par vagues</i> | 25000 | | (0 0) | | (5 100) |
| | | | | | |
| <i>Obsessionnel</i> | 9000 | | (0 0) | | (5 100) |
| | | | | | |
| <i>Qui tourne</i> | 18000 | | (0 500) | | (100 100) |
| | | | | | |

| | | | | | | |
|--|-------|---|--------------|---|-----------|---|
| <i>Élan</i> (in <i>F</i>) | 3000 |  | (0 2000) |  | (0 100) | In this simulation, we chose three successive <i>élans</i> in <i>F</i> . In that case, only the first <i>élan</i> needs a preparation. A reducing of the intensity is needed on each layer to draw a frontier between the <i>élans</i> . |
| <i>Élan</i> (in <i>I</i>) | 1500 |  | (200 200) |  | (10 100) | Here, we have reproduced a simple <i>élan</i> in <i>I</i> . As in the case of an <i>élan</i> in <i>F</i> , the exponential profile has to be a short one. |
| <i>Chute</i> | 5000 |  | (0 2500) |  | (100 100) | We have added a slide in the frequency profile to insist on the triggering of the fall. The curved profile is comparable to that of the <i>élan</i> (the <i>Chute</i> might be ascending), but of a greater length (T2 instead of T1). |
| <i>Trajectoire inexorable</i> (in <i>F</i>) | 20000 |  | (-2400 2400) |  | (100 100) | Here we see a slowly decreasing linear function of the frequency. An ascending function is also suitable. |
| <i>Trajectoire inexorable</i> (pulsed in <i>I</i>) | 15000 |  | (0 0) |  | (0 100) | Here is a <i>peigne</i> in intensity with an acceleration. A slowing-down of the <i>peigne</i> leads to the same UST. |
| <i>Trajectoire inexorable</i> (in <i>I</i>) | 20000 |  | (0 0) |  | (10 100) | In this example, we have used a slowly increasing curved function of the frequency. That simulation does not correspond to any example of the CD; but it was admitted as a <i>Trajectoire inexorable</i> by MIM members. |
| <i>Sur l'erre</i> | 10000 |  | (0 600) |  | (0 100) | In this simulation, there are two alternative notes, forming an interval of three semitones, while the global intensity exponentially decreases (10s). |
| <i>Étirement</i> | 8000 |  | (200 200) |  | (100 100) | Here, we have taken a short extract (0.1s) from the initial sound-file, deprived of any frequency variation. |
| <i>Freinage</i> | 2500 |  | (600 600) |  | (0 100) | This simulation is based on a regular <i>peigne</i> of intensities, which is followed by a decelerating <i>peigne</i> . |
| <i>Contracté étendu</i> | 15000 |  | (0 600) |  | (0 100) | As regards frequencies in that example, the time-function uses two profiles: one is random and by layers (4s) and the other one is constant (11s). On the intensity level, the time-function is formed by a sequence of three profiles: the first one is organized in accelerated peaks of increasing amplitude, the second one is a very short impulse and the last one is a <i>plat</i> . |
| <i>Suspension interrogation</i> | 10000 |  | (0 600) |  | (0 100) | In that simulation, frequencies evolve according to a sequence of four values repeated with variation (slowly moving with changes in height) during 3s, followed by a constant phase (7s). Intensities vary |

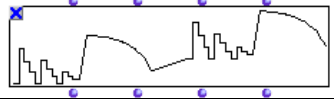
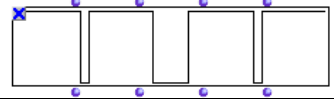
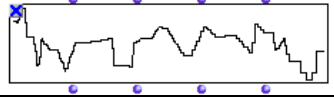
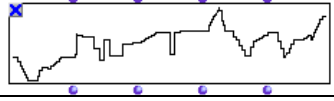
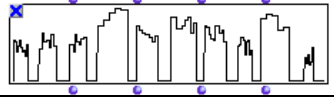
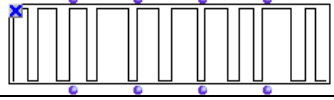
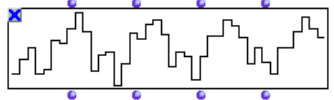
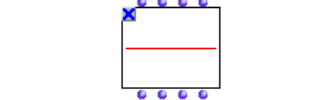
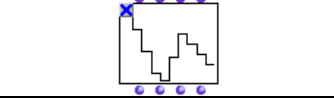
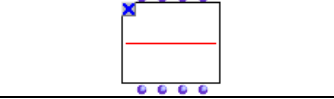
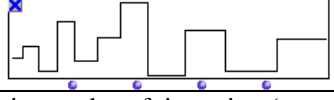
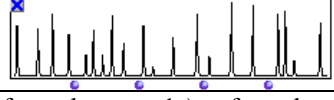
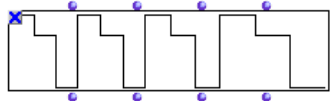
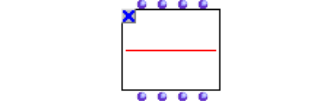
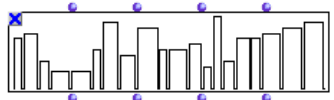
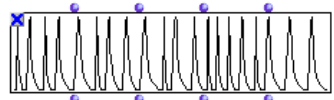
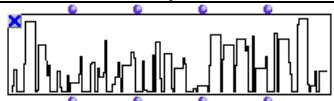
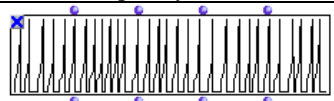
| | | | | | |
|--|--|---|-----------------|---|-----------|
| | according to a first ascending and linear profile, then to a decreasing and curved second profile. | | | | |
| <i>Qui veut démarrer</i> | 10000 |  | (-1200 1200) |  | (0 100) |
| | Here, frequencies evolve according to an organized sequence, followed by a decreasing curved shape, the ensemble is repeated with variations in height. The intensities are constant here: frequencies are separated by some rests (0 intensity). | | | | |
| <i>Sans direction par divergence d'information</i> | 25000 |  | (-2400 2400) |  | (10 100) |
| | In this example, frequency and intensity variations are sequences (motions) of random length and speed. | | | | |
| <i>Sans direction par excès d'information</i> | 15000 |  | (-1000 0) |  | (10 100) |
| | This simulation is made up of the superposition of four sound-files we got from four profiles of the type that is displayed. Each frequency profile is made up of constructed sequences of random length and speed. Intensity profiles are flat, they separate sequences from one another. Here, we have taken four tracks of frequency variation so as to constitute different layers of sound: (-1000 0), (500 1500), (2000 2500) and (3000 3500). | | | | |
| <i>Stationnaire (cyclique)</i> | 32000 |  | (0 600) |  | (100 100) |
| | Here, we use a cycle of frequencies slowly repeated four times (8s each) with variations. | | | | |
| <i>Stationnaire simple</i> | 20000 |  | (-600 0) |  | (100 100) |
| | To simulate this UST, we have taken four slowly marked out (20s) values, random in frequency. | | | | |
| <i>En flottement</i> | 20000 |  | (0 2400) |  | (0 100) |
| | Low density peaks of intensity (separated by rests often close to 1s), of random position and amplitude, provide a selection of snatches whose frequencies are, in themselves, random. In this simulation, the continuum is a rest. | | | | |
| <i>En suspension</i> | 15000 |  | (600 1200) |  | (50 50) |
| | In this simulation, we have used a cell of three frequency values, repeated four times slowly, while the intensity is constant. | | | | |
| <i>Lourdeur</i> | 20000 |  | (0 1200) |  | (0 100) |
| | The present UST is simulated thanks to large irregular bell-shaped profiles (of variable length about 1s) applied to the intensity, and combined with layers of random frequency. | | | | |
| <i>Qui avance</i> | 15000 |  | (0 2000) |  | (0 100) |
| | Here, we have set up groups of three values random in frequency, separated by rests of variable length, with an intensity profile increasing on the three notes. The sound which is produced by that simulation is added to the transposed initial sound, so as to create a seemingly necessary continuum. | | | | |

5 Application of that model to visuals.

The first observation of the application of the MTP model occurred during Kari Baete Tandberg's presentation of a work during the Summer School at the University of Tromsø in June 2005. She wanted to transcribe into music a picture representing a stretch of water on which raindrops were starting to fall. To make that transcription, she captured the time variation of the image luminosity integrated in the

whole picture. Then, she got a relatively flat time-curve, randomly punctuated by short and irregular peaks. This curve is typical of MTP 17, which characterizes a UST *En flottement*. Consequently, she used the curve to synchronize a sound generator which produced a continuous background noise on which sound events - functions of the peak level - were added. That sound was really *En flottement*. It should be clarified that Kari Baete Tandberg did not know about the theory of UST and that her approach was an artistic one, not a simulation. However, This example shows that the analysis in MTP can happen to be totally pertinent for the analysis and the synchronization of multimedia works.

We also made a quantitative analysis in MTP and UST of *Rhythm 21* by Hans Richter. This work was chosen because of the scarcity of time-related variables in it: the piece is composed of black and white rectangles on backgrounds of the opposite colour, whose surfaces and positions vary. We were able to cut that work in MTP precisely and totally, without any problem. We were able to find several UST, the main one being the *Trajectoire inexorable*. Only two pertinent variables are used in that work, F being here materialized by the size of the elements and I by their position. In visuals, these variables are not conveyed by any particular rectangle but they characterize a group pattern of the geometrical parameters (centre or edge elements): position and size.

An important phenomenon was noted during that analysis: MTP do not depend on the work but on the analyzed document in context of its reception. That distinction was already very clear in the analysis of sound documents: UST and MTP are not inscribed in the score, instead they crucially depend on the musical interpretation, so as to have the MIM composers struggling over the correct execution of the examples they themselves have composed. The importance of the context of reception is just as great as far as visuals are concerned. The analysis was made on a digitized video file and depending on the screen that was used (analogical or flat), the UST and MTP varied in certain spots in the file.

6 Conclusion

Our model provides an operational basis on which to set up simulations, and also provides numerous quantitative criteria. It is open enough to be applied broadly, and it should be interesting to seek how other sound classifications, especially those established on great lengths, could be deconstructed into profiles and profilemes. The decomposition system which we propose can be applied to them. Such a deconstruction should permit the determination of how UST are combined together in these classifications. Finally, our model succeeds in its main aim, which was to provide a description adaptable in computing. That model easily allows the taking into account of more than two variables and it can be applied to the field of visuals. Visuals being tabular and non-linear, it is probable that the simple transposition of Motifs into variables is not sufficient to describe the entire units which we are to encounter.

The analysis in MTP also shows that the reading of an audiovisual artistic document is largely dependent on the context of its reception and that it could not be applied a theory based on the philology/hermeneutics interrelation; reading an artistic document consists in living its effective perception and not in intellectually reconstructing a hypothetical referent document¹⁴.

7 References

Daquet Alice, 2004. *Étude de la pertinence psychologique des « Unités Sémiotiques Temporelles »*, mémoire de maîtrise de psychologie cognitive 2003-2004 sous la direction de Charles Tijus et Stephen Mc Adams, University of Paris.

¹⁴ Such a document may exist in a digitized video file, but certain computerized works such as the adaptive poetical generators take into account the absence of that document in their conception.

Delalande François, 1989. La terrasse des audiences au clair de lune : essai d'analyse esthétique. La prise en compte des écoutes-types comme points de vue d'analyse. *Analyse musicale* 16, 75-84.

-----, 1991. L'analyse musicale, discipline expérimentale ? *Analyse musicale* 23, 11-20

Klinkenberg, Jean-Marie, 1996. *Précis de sémiotique générale*. Liège: De Boeck & Larcier.

MIM, 1996. *Les Unités Sémiotiques Temporelles, éléments nouveaux d'analyse musicale*. Marseille: MIM.

-----, 2002. *Les Unités Sémiotiques Temporelles, nouvelles clefs pour l'écoute, outil d'analyse musicale*. CD-ROM. Marseille: MIM.